



EASYHOME



CATENE

FISSAGGIO

TRECCE

ELASTICI

CINGHIE

FASCE

FUNE

FILO

CAVETTO

CINTINO





LEGENDA

BxA

MISURE
CONFEZIONE



COLORE



CARICO DI
ROTTURA



LARGHEZZA
BOBINA



PEZZI CT

TRECCHE

La gamma di trecce ZA, è adatta a soddisfare tutte le esigenze dei nostri Clienti, sia di tipo "Professional", sia di tipo "Family". Le caratteristiche dei materiali utilizzati: filati ad Alta Tenacità di Nylon, Poliestere, Polipropilene e Yuta Naturale, sono idonee a moltissimi campi di utilizzo: Agricoltura, Giardinaggio, Edilizia, Industria, Ferramenta, Tendaggi, Nautica, Trasporti.

I packaging proposti sono ricchi di informazioni e tabelle esaustive, complete di confronti tra i vari materiali, per aiutare il Cliente finale nella scelta del prodotto più idoneo alle sue esigenze. Viene proposta sia la versione pretagliata, confezionata nelle metrature più vendute, sia la versione per la vendita a metro per la Clientela "Professional", che necessita di particolari metraggi. Una particolare attenzione è stata data al mondo dell'Edilizia, con una proposta molto ampia di articoli innovativi, con packaging attrattivi e accattivanti per un acquisto d'impulso.

GUIDA ALL'ACQUISTO				
N°	CARATTERISTICA	POLIPROPILENE	POLIESTERE	YUTA
1	Galleggiamento in acqua	Ottimo	Affonda	Ottimo
2	Assorbimento d'acqua	Basso	Basso	Alto
3	Resistenza in acqua	Ottima	Ottima	Bassa
4	Carico di rottura	Buona	Ottima	Bassa
5	Allungamento sotto sforzo	Alto	Basso	Basso
6	Grado °C di fusione	165°C	260°C	—
7	Resistenza all'attrito	Buona	Ottima	Bassa
8	Resistenza ai raggi UV	Moderata	Ottima	Bassa
9	Resistenza nel tempo	Buona	Ottima	Bassa
10	Smaltimento prodotto	100% riciclabile	100% riciclabile	100% riciclabile

CONFEZIONI PRETAGLIATE



TRECCHE MULTIUSO A 16 FUSI IN POLIESTERE AD ALTA TENACITÀ

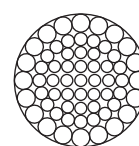

Art	Barcode 805609...	BxA cm		Ø	Mt	
PE05B25	5634875	15x28	BIANCO	5	25	10
PE06B25	5634813	15x28	BIANCO	6	25	10
PE08BV10	5634882	15x28	BIANCO VERDE	8	10	10



TRECCIA PER RILOGHE AD 8 FUSI IN POLIPROPILENE AD ALTA TENACITÀ STABILIZZATO ANTI UV

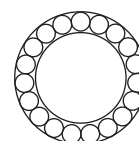

Art	Barcode 805609...	BxA cm		Ø	Mt	
PPR25B20	5634684	9x23	BIANCO	2.5	20	20
PPR25B100	5634691	15x28	BIANCO	2.5	100	6

SPAGHI MULTIUSO

BOBINE PICCOLE



Art	Barcode 805609...	BxA cm	Ø mm	Mt	MATERIALE	D cm	H cm	
SPR1995B	5635421	5x10	1.9	95	RAFFIA BIANCA	5	10	6
SPR1995V	5635438	5x10	1.9	95	RAFFIA VERDE	5	10	6
SPS2718	5635452	5x10	2.7	18	SISAL NATURALE	5	10	6
SPY185	5635476	5x10	1	85	YUTA NATURALE	5	10	6
SPP1380B	5635490	5x10	1.3	80	PLASTIFICATO BIANCO	5	10	6
SPC1120	5635506	5x10	1	120	COTONE ALIMENTARE	5	10	6
SPL0680	5635513	5x10	0.6	180	LINO NATURALE	5	10	6

SPR1995B

SPR1995V

SPS2718

SPY185

SPP1380B

SPC1120

SPL0680



BOBINE GRANDI

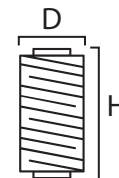

Art	Barcode 805609...	BxA cm	Ø mm	Mt	MATERIALE	D cm	H cm	
SPR13450	5635360	9x15	1.3	450	RAFFIA BIANCA	9	15	4
SPR19225	5635377	9x15	1.9	225	RAFFIA BIANCA	9	15	4
SPS2770	5635469	9x15	2.7	70	SISAL NATURALE	9	15	4
SPY1340	5635483	9x15	1	340	YUTA NATURALE	9	15	4

SPR13450

SPR19225

SPS2770

SPY1340



GOMITOLI

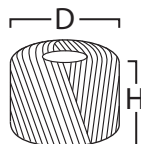

Art	Barcode 805609...	BxA cm	∅	D cm	H cm	Mt	MATERIALE	
SPR1280	5635407	8x6	1.2	8	6	80	RAFFIA AVANA	6
SPR1580	5635414	9x7	1.5	9	7	80	RAFFIA AVANA	6
SPR2420	5635445	7x6	2.4	7	6	20	RAFFIA AVANA	8

FILO NYLON



Art	Barcode 805609...	BxA cm	∅	Mt		
SPN1820	5635520	12x12	1.8	20	BIANCO	10
SPN3020	5635537	14x14	3	20	BIANCO	10

FILO PESCA



Art	Barcode 805609...	BxA cm	∅	Mt		
SPN03100	5635384	8x16	0.3	100	TRASPARENTE	15
SPN06100	5635391	8x16	0.6	100	TRASPARENTE	15

CONFEZIONI PER OFFERTE SPECIALI



Art	Barcode 805609...	BxA cm	∅	Mt		
PP	5634585	9x23	4	10	MISTI	10

Esposizione completa LINEA SPAGHI MULTIUSO su ripiano sospeso.



TRECCIA PER VENEZIANE



A 16 FUSI IN POLIPROPILENE AD ALTA TENACITÀ STABILIZZATO ANTI UV

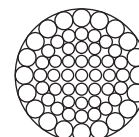

BLISTER MT 20



Art	Barcode 805609...	BxA cm		Ø	Mt	
PP03B20	5634714	9x23	B	3	20	20
PP03BL20	5634721	9x23	BL	3	20	20
PP03G20	5634738	9x23	G	3	20	20
PP03M20	5634745	9x23	M	3	20	20
PP03N20	5634752	9x23	N	3	20	20
PP03R20	5634769	9x23	R	3	20	20
PP03V20	5634776	9x23	V	3	20	20
PP03VS20	5634783	9x23	VS	3	20	20

BOBINA MT 100



Art	Barcode 805609...	BxA cm		Ø	Mt	
PP03B100	5634790	12x11	B	3	100	6
PP03BL100	5634806	12x11	BL	3	100	6
PP03R100	5634844	12x11	R	3	100	6
PP03V100	5634851	12x11	V	3	100	6
PP03VS100	5634868	12x11	VS	3	100	6

A 16 FUSI IN POLIESTERE AD ALTA TENACITÀ

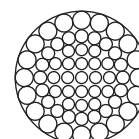

Art	Barcode 805609...	BxA cm		Ø	Mt	
PE03B20	5634912	9x23	B	3	20	20
PE03G20	5634592	9x23	G	3	20	20

TRECCIA NAUTICA TRADIZIONALE IN POLIESTERE BIANCO CON SEGNALINO GIALLO E NERO CON ANIMA BIANCA IN POLIESTERE PER VENDITA A KG

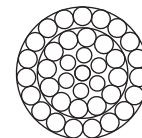
B BIANCO

GI+N
SEGNALINO GIALLO + NERO

Art	Ø		Mt Circa	Kg Circa		Bobina	
TR04	4	B + GI + N	650	11	250	Ø: 26cm H: 26cm	1
TR04B	4	B	650	11	250		1
TR05	5	B + GI + N	470	12	350		1
TR05B	5	B	470	12	350		1
TR06	6	B + GI + N	500	16	500	Ø: 30cm H: 30cm	1
TR06B	6	B	500	16	500		1
TR08	8	B + GI + N	300	16	800		1
TR08B	8	B	300	16	800		1
TR10	10	B + GI + N	200	16	1200		1
TR10B	10	B	200	16	1200		1
TR12	12	B + GI + N	145	17	1900	1	
TR14	14	B + GI + N	150	21	2200	Ø: 34cm H: 34cm	1
TR16	16	B + GI + N	120	21	2600		1
TR18	18	B + GI + N	100	25	3100		1
TR20	20	B + GI + N	100	29	3900	Ø: 34cm H: 40cm	1
TR22	22	B + GI + N	90	31	4300		1
TR24	24	B + GI + N	80	31	4800		1

Le misure della bobina, diametro flangia ed altezza, sono indicate nella colonna "Bobina" della tabella in alto.

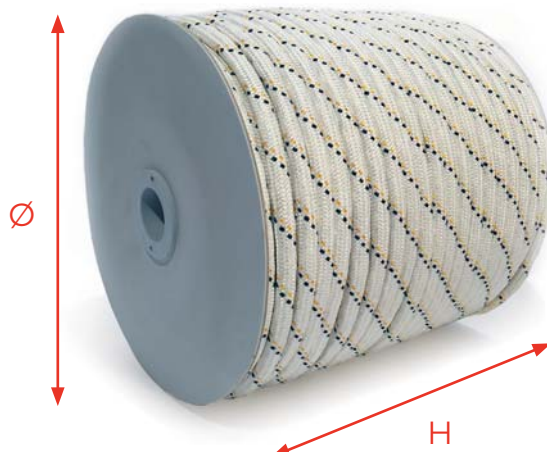

TRECCIOLINA PER EDILIZIA AD 8 FUSI IN POLIPROPILENE AD ALTA TENACITÀ STABILIZZATO ANTI UV

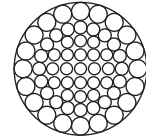

Art	Barcode 805609...	BxA cm		Ø	Mt	
PP18B50	5634615	9x23	BIANCO	1.8	50	20
PP18GI50	5634820	9x23	GIALLO	1.8	50	20
PP18R50	5634837	9x23	ROSSO	1.8	50	20
PP18VS50	5634622	9x23	VERDE SCURO	1.8	50	20
PP18BR50	5634608	9x23	ROSSO BIANCO	1.8	50	50



IN BOBINA

Art	Barcode 805609...	BxA cm		Ø	Mt	
PP18BR200	5634653	8x16	ROSSO BIANCO	1.8	200	15
PP18GF200	5634660	8x16	GIALLO FLUO	1.8	200	15



BOBINA RIAVVOLGIBILE CON MANICO GIREVOLE

Art	Barcode 805609...	BxA cm		Ø	Mt	
PP18AR100	5639108	10x17	ARANCIO FLUO	1.8	100	15
PP18BR100	5634639	10x17	ROSSO BIANCO	1.8	100	15
PP18GF100	5634646	10x17	GIALLO FLUO	1.8	100	15
PP18VF100	5639115	10x17	VERDE FLUO	1.8	100	15
PP18BR250	5634677	10x25	ROSSO BIANCO	1.8	250	15



DISPLAY ZA' EASY FAST PRATICO ESPOSITORE DA 18 PZ IN VARI COLORI

Art	Barcode 805609...	BxA cm		Ø	Mt	
PP18AR	5638514	37x28	ARANCIO FLUO	1.8	100	1
PP18BR	5638521	37x28	ROSSO BIANCO	1.8	100	1
PP18GF	5638538	37x28	GIALLO FLUO	1.8	100	1
PP18VF	5638552	37x28	VERDE FLUO	1.8	100	1
PP18MIX	5638545	37x28	6 PZ ARANCIO, 6 PZ GIALLO, 6 PZ VERDE	1.8	100	1



Misure display
ZA' EASY FAST

L 37cm
P 28cm
H 40cm



TRECCIE IN BOBINE PER VENDITA AL MT

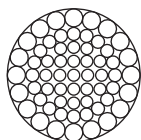

TRECCIA A 16 FUSI IN POLIPROPILENE AD ALTA TENACITÀ STABILIZZATO ANTI UV



Art	Barcode 805609...		Ø	Mt			
PP05140	5635070	B/R/BL	5	140	200	10	1
PP06080	5635087	B/R/BL	6	80	320	10	1
PP08050	5635094	B/R/BL	8	50	550	10	1
PP10070	5635100	B/R/BL	10	70	850	20	1
PP12040	5635117	B/R/BL	12	40	1250	20	1
PP14030	5635124	B/R/BL	14	30	1740	20	1
PP16040	5635131	B/R/BL	16	40	2100	30	1

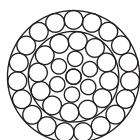

TRECCIA A 16 FUSI IN POLIESTERE AD ALTA TENACITÀ



Art	Barcode 805609...		Ø	Mt			
PE05140	5635025	B/V	5	140	300	10	1
PE06080	5635032	B/V	6	80	440	10	1
PE08050	5635049	B/V	8	50	790	10	1
PE10070	5635056	B/V	10	70	1230	20	1
PE12040	5635063	B/V	12	40	1900	20	1
PE14030	5635544	B/V	14	30	2400	20	1
PE16050	5635551	B/V	16	40	3150	30	1

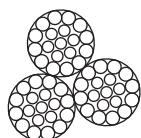

TRECCIA A 3 LIGNOLI IN NYLON AD ALTA TENACITÀ



Art	Barcode 805609...		Ø	Mt			
PE08B40	5634554	B	8	40	880	10	1
PE08N40	5634561	N	8	40	830	10	1
PE12B50	5634578	B	12	50	1900	20	1
PE12N50	5635735	N	12	50	1790	20	1
PE16B50	5635742	B	16	50	2950	30	1
PE16N50	5635759	N	16	50	2800	30	1



TRECCIA GALLEGGIANTE IN MONOFILO DI POLIPROPILENE

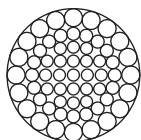

Art	Barcode 805609...		Ø	Mt			
PPG08070	5634899	AR	8	70	330	10	1
PPG10070	5634905	AR	10	70	570	20	1

TRECCIA PER VENEZIANE A 16 FUSI IN POLIPROPILENE STABILIZZATO ANTI UV

Art	Barcode 805609...		Ø	Mt	Ø 20 cm / ...cm	
PP03A300	5635568	A	3	300	10	1
PP03B300	5635209	B	3	300	10	1
PP03BL300	5635216	BL	3	300	10	1
PP03C300	5635223	C	3	300	10	1
PP03G300	5635230	G	3	300	10	1
PP03GI300	5635247	GI	3	300	10	1
PP03M300	5635254	M	3	300	10	1
PP03N300	5635261	N	3	300	10	1
PP03R300	5635278	R	3	300	10	1
PP03V300	5635285	V	3	300	10	1
PP03VS300	5635292	VS	3	300	10	1

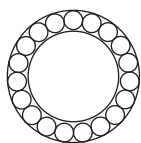
TRECCIA PER RILOGA A 8 FUSI IN POLIPROPILENE AD ALTA TENACITÀ STABILIZZATO ANTI UV

Art	Barcode 805609...		Ø	Mt	Ø 20 cm / ...cm	
PPR25400	5635193	B	2.5	400	10	1
PPR03B300	5635148	B	3	300	10	1

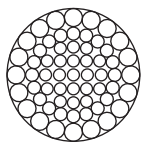

TRECCIA BIANCA AD 8 FUSI IN POLIPROPILENE AD ALTA TENACITÀ STABILIZZATO ANTI UV

Art	Barcode 805609...		Ø	Mt	KG	Ø 20 cm / ...cm	
PPM04220	5635155	B	4	220	110	10	1
PPM05140	5635162	B	5	140	200	10	1
PPM06090	5635179	B	6	90	250	10	1
PPM08050	5635186	B	8	50	500	10	1

TI SERVE LA BITTA PER FISSARE LA TRECCIA?

Vai a pag. 38. Troverai quella più adatta a te e molti altri articoli.

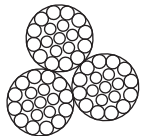



TRECCIA A 3 LIGNOLI IN YUTA NATURALE



Art	Barcode 805609...		Ø	Mt		Ø 20 cm! ...cm	
YU05140	5635575	A	5	140	190	10	1
YU06080	5635308	A	6	80	250	10	1
YU08050	5635315	A	8	50	380	10	1
YU10070	5635322	A	10	70	590	20	1
YU12040	5635339	A	12	40	870	20	1
YU14030	5635346	A	14	30	1150	20	1
YU16040	5635353	A	16	40	1750	30	1
YU30010	5635582	A	30	10	4900	30	1

NASTRI IN POLIPROPILENE AD ALTA TENACITÀ

B BIANCO



N NERO



BL BLU



R ROSSO



Art	Barcode 805609...		Ø	Mt		Ø 20 cm! ...cm	
PPN25B070	5634929	B	25	70	250	10	1
PPN25N070	5634936	N	25	70	245	10	1
PPN30B040	5634943	B	30	40	280	10	1
PPN30BL040	5634950	BL	30	40	280	10	1
PPN30N040	5634967	N	30	40	275	10	1
PPN30R040	5634974	R	30	40	280	10	1
PPN40B030	5634981	B	40	30	350	10	1
PPN40N030	5634998	N	40	30	320	10	1
PPN50B025	5635001	B	50	25	510	10	1
PPN50N025	5635018	N	50	25	480	10	1

Per calcolare la quantità di bobine da inserire nelle 2 sezioni indipendenti del Vassoio Portabobine **ZA'** (Art. 1C pag. 18) consultare la colonna "Ø 20 x ...cm" della tabella relativa, considerando uno spazio utile di **MASSIMO 98cm** per ogni sezione.

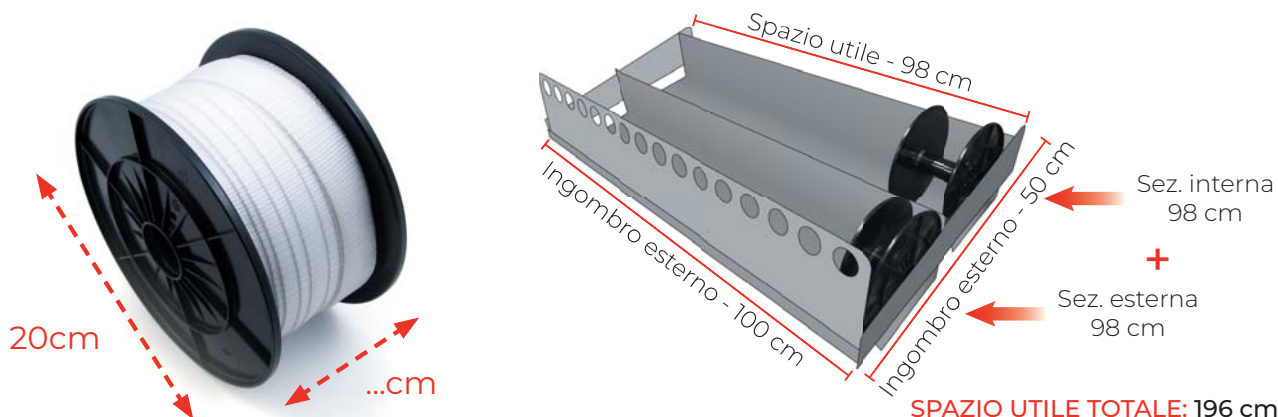



ZA' srl



Via Sile, 37/14
31033 CASTELFRANCO V.TO (TV)



0423 724644 - 420401



0423 1911377



www.zasrl.com